

## DEVELOPMENT OF MANUFACTURING FEATURES WITH ADVANCED PARAMETRIZATION POSSIBILITIES

**Alexander Sharmazanashvili**

CAD/CAM Division  
Georgian Technical University  
Georgia  
sharm@gtu.edu.ge

### ABSTRACT

*Connectivity by knowledge is a core approach for integration of two sophisticated processes of Product and Process Modeling (PPM). This concept concerns with knowledge formalization and sharing between up and down stages of PPM. The key in this consideration is shape representation because different stages of PPM are associated with definition of product shape. As a result the shape formal representation can be considered as a limitation of decision making alternatives during PPM. This paper represents the advanced approach of shape formalization for manufacturing process, which can be implemented as a limitation on the conceptual designing stage to ensure manufacturability of design.*

### KEYWORDS

Shape, formalism, parameterization scheme, conjunction point, typical structure, modification, class, stair, manufacturing feature

### 1. INTRODUCTION

Integrated feature-based modeling is a widely implemented approach. The theoretical background in feature formalization and identification is well developed. Most of the world class leaders in computer aided tools, such as CATIA, Pro/Engineering, I\_DEAS, Unigraphics, etc. are built on the base of this technology.

However, the major contribution of the research is given to feature modeling systems of product design, while investigation in feature-based modeling of manufacturing processes is comparatively rare and the majority of studies in this field concern the formalization of empirical knowledge on the base of group technology and tipification of processes. As a result, product features in most of cases do not directly correspond to process features.

Generally, PPM environment has to be considered as an entire space of interrelated corporate knowledge (Owen, 2002). Consideration of common knowledge as a base of decision making models for product modeling and process modeling enables to capture manufacturing process requirements during conceptual designing and ensure manufacturability of design. Systematical approach of knowledge connectivity in this case has to be developed.

The core in this development is shape representation for manufacturing process formalization. The shape describes the entire originality of manufacturing technology. Therefore the process requirements are linked and can be expressed through the shape representation.

Several approaches are used in manufacturing process formalization. DFM concept from Boothroyd&Dewhurs considers [2] regular shapes, therefore as it was shown in our research (Naskidashvili, 2002) [3] considerable inaccuracy of cost calculations will emerge in case of evaluation of the design with complex shapes.

Many of studies concern manufacturing shape representation by two main classes of shapes: primary shapes, which describe a global shape of product and auxiliary shapes, with typical shapes, such as holes, ears, fillets, ribs, etc. Typical representatives of this approach are (Kapustin, 1976), (Poldermann et al 1996), etc.

Another consideration of manufacturing shapes is given in CNC machines where a formal description of typical processes of material removal for regular shapes is built in the form of fixed cycles. Many of them (Sinumeric, Fanuc, etc.) support a special language for shape representation and process programming to extend the existing library of cycles. Therefore, it gives an opportunity for knowledge sharing between product modeling, process modeling and process control stages and integrates decision-

making models of corresponding systems, Sharmazanashvili [6].

The paper describes a possible step forward in formalization of non-complex manufacturing shapes and represents our point of view in 2D shape systematization for knowledge connectivity in PPM. This approach was developed in CAD/CAM division at Georgian Technical University.

## 2. STATEMENT OF PROBLEM

Manufacturing shape is associated with stock of material which has to be removed during machining. The stock is described from one side, by the shape of the part which has to be received after removing material during the operation, and from the other side, by the shape of workpiece.

Generally three main types of the stock can be considered:

1. Open stock – limiting tool cutting movement from one side (figure 1, a)
2. Half-Open stock – limiting tool cutting movement from two side (figure 1, b)
3. Close stock – limiting tool cutting movement from three sides (figure 1, c).

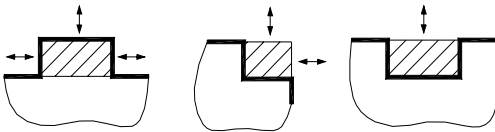

Figure 1 General types of manufacturing stocks

The plane consideration is typical for turning, laser and plasma cutting operations. In case of a 3-dimensional movement of cutting tool – operations of milling, grinding, etc., an additional degree of freedom has to be added to the above mentioned consideration.

Usually a full stock is complex and separation of stocks with comparatively simple and typical shapes is needed to ensure the optimal conditions for material removal process. Figure 2 represents a full stock for turning. The operation structure is usually built according to the calculated value of the depth of the cut ( $t$ ) (figure 3). However, for some pieces ( $ab$  and  $cd$  on figure 3) the real depth of the cut is less than calculated

$$t_{ab} < t \quad t_{cd} < t$$

This is an undesirable condition for cutting, while the temperature and tool wear intensity is unevenly distributed along the edge of the cut and the cutter can damage [11]; the surface accuracy and rough will be different from the expected because the parameters of cutting force  $P_y$  and  $P_z$  are different from the calculated.

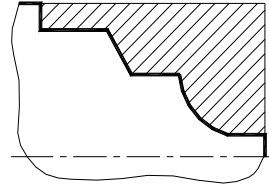

Figure 2 Full stock representation

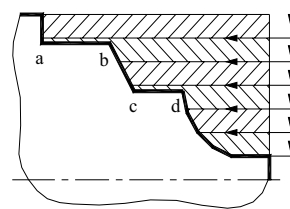

Figure 3 Stock distribution according to the depth of the cut

Therefore, the full stock has to be divided into the several blocks. Ensuring an equal depth of the cut during each cutting movement of the cutter is the main criteria of block separation in this case [12], [13]. Different ways of block separation exist for the considered example (figure 4).

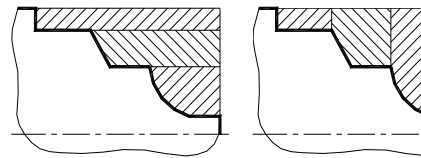

Figure 4 Two ways of block separation from the full stock

The main geometrical feature of considered above blocks is shape in form of “STAIR”, which connect two neighbor parallel surfaces with each other. These surfaces are base for calculation of depth of cut and depending on tool undercut movement direction; they will be parallel to the axis – X, Y, or Z. For example,

in case of longitudinal movement of tool, base surfaces of turning block presented on figure 5 are  $a-d$  and  $b-c$ , while for diametrical movement, surfaces  $d-c$  and  $a-b$ .

Thus, shape in form of stair can be considered as a main manufacturing shape which represents material removing process realization requirements. Below is given stair systematization and considered advanced possibilities for parameterization. Formalization is done for turning stairs; however results are not restricted, while they can be easily transformed for 3D shapes for the operations of milling, grinding, etc.

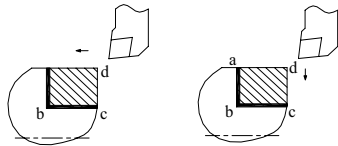

Figure 5 Consideration of base surfaces

### 3. CONSIDERATION OF STAIR FORMALIZM

In case of turning, *two* neighboring cylindrical surfaces can be connected by conical, end face or by arc surfaces in clockwise or anticlockwise directions (figure 6).

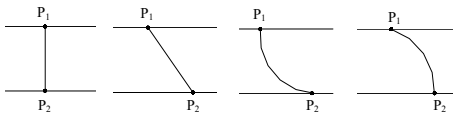

Figure 6 Base surface for turning

By assigning name to surfaces, **C** – conic, **L** – cylindrical, **F** – end face;  $A^+$  – clockwise arc and  $A^-$  – anticlockwise arc, it is possible to write structural equations of elementary stairs considered above.

$$\left\{ \begin{array}{l} ST1 = \{L_1 \wedge F \wedge L_2\} \\ ST2 = \{L_1 \wedge C \wedge L_2\} \\ ST3 = \{L_1 \wedge A^- \wedge L_2\} \\ ST4 = \{L_1 \wedge A^+ \wedge L_2\} \end{array} \right. \quad (1)$$

Where “ $\wedge$ ” represents logical AND.

For half-open stocks  $L_1$  cylindrical surface does not belong to the part surface but to workpiece surface, so in (1) structural equations  $L_1$  can be changed by conjunction point  $P_1$

$$\left\{ \begin{array}{l} ST1 = \{P_1 \wedge F \wedge L_2\} \\ ST2 = \{P_1 \wedge C \wedge L_2\} \\ ST3 = \{P_1 \wedge A^- \wedge L_2\} \\ ST4 = \{P_1 \wedge A^+ \wedge L_2\} \end{array} \right. \quad (2)$$

Next step in stair systematization is a formation of a more complex description from elementary stairs. It is possible by connected surfaces in structural equations by the logical OR – “ $\vee$ ”. In this case end face surface (F) can be considered as a private case of a conic surface (C)  $F=C_{(\alpha=90)}$  and a separation of complex stair done by typical conjunction of three surfaces (C), ( $A^-$ ) and ( $A^+$ ). Therefore, following groups of typical conjunctions will be received

- GROUP I :  $C \vee A^- \vee A^+$
- GROUP II :  $A^- \vee A^+ \vee C$
- GROUP III:  $A^- \vee C \vee A^+$

Each group unifies the number of original conjunctions. For example, typical structures ( $C \vee A^-$ ); ( $C \vee A^+$ ); ( $A^- \vee A^+$ ); ( $A^- \vee A^+$ ) belong to group 1, etc. By comparing groups according to total number of original structures, it is possible to identify that the 3<sup>rd</sup> group is more complex, because while it's contain all typical structures of 1<sup>st</sup> and 2<sup>nd</sup> groups and several structures in addition. So, group 1 and group 2 will be omitted from consideration.

Group 3 contains *two* subgroups:

- GROUP 3-1:  $A^+ \vee C \vee A^-$
- GROUP 3-2:  $A^- \vee C \vee A^+$

Our research shows that in most of the cases cylindrical surfaces are connected with a clockwise arc surface. Therefore it's preferable to consider a clockwise arc as the first surface in stair structure. So group 3-2 will be final solution in our consideration.

Thus, the final structure of half-open stair will contain typical connection of  $P_1 \rightarrow A^+ \rightarrow C \rightarrow A^- \rightarrow L_2$ . Mark up the conjunction points including center points of arc by  $P_1, P_2, \dots, P_7$ . As a result, the geometrical structure can be expressed by a graph, where vertexes are corresponding to conjunction points and tangents express connection between points (figure 7).

### 4. PARAMETERIZATION PARADIGM

Next step in stair systematization is working out the parametric representation and separation of that minimal amount of parameters which are necessary

and enough for the geometrical definition of all conjunction points in the considered structure.

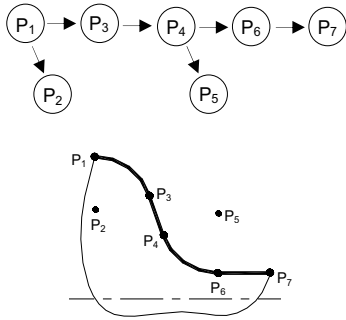

**Figure 7** Representation of geometrical structure of half-open stair

Conjunction points can be defined through the connected parameters which are described coordinates of each point along Z and X axis (XOZ is a machining axis in case of turning). However, this will increase a total number of formal parameters, therefore just only minimal amount of points –  $P_1$ ,  $P_7$  and center point of arc  $P_2$ ,  $P_5$  have to be defined by connected parameters.

Thus, formal parameters for  $P_1$  will be:  $Z_1$  –  $P_1$  coordinate along the Z axis and  $D_1$  – diameter of circle which is drawn by the turning of  $P_1$  point around the Z axis. In the same way, parameters  $Z_2$ ,  $D_2$  will be associated with  $P_2$  point,  $Z_3$ ,  $D_3$  with  $P_5$  point and  $Z_4$ ,  $D_4$  with  $P_7$  point.

For the rest of the points –  $P_3$ ,  $P_4$ ,  $P_6$  local parameters are implemented:  $\alpha$  – angle of conical surface and  $R_1$  – radius of  $A^+$  arc, permits to define  $P_3$  point;  $R_2$  – radius of  $A^-$  arc, with combination of  $\alpha$ , permits to define  $P_4$  point. In case of  $P_6$  point,  $R_2$  and  $D_4$  parameters are needed.

By adding on graph of structure (figure 7) tangents, which are express associations between conjunction points and formal parameters of their description, we can receive final representation of parameterization for half-open stair (figure 8).

Special cases of representation of geometry can be existed according to given scheme of parameterization. Parameters  $R_1$ ,  $D_2$  and  $Z_2$  are exchangeable. It means that if  $D_2$ ,  $Z_2$  is described, parameter  $R_1$  will be calculated and if  $R_1$  is described,  $D_2$  and  $Z_2$  are calculated. This is a private case of the previous one, because tangent conjunction

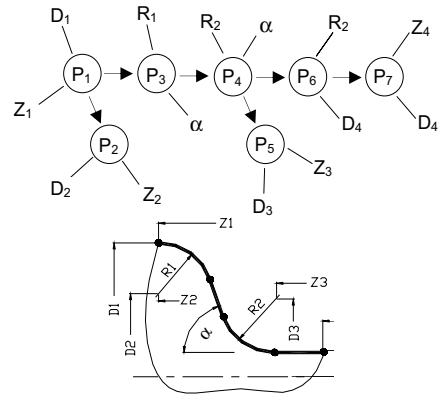

**Figure 8** Parameterization scheme of half-open stair

with line and  $A^+$  arc in  $P_1$  point will exist each time. However, the above consideration is right only for that cases, when  $Z_3$ ,  $D_3$  parameters are not defined. In case of their definition with additional  $\alpha$  and  $R_2$  parameters and if tangent conjunction in  $P_4$  point is carried out, in  $P_3$  point non-tangent conjunction of  $L_2$  line and  $A^+$  will exist and  $R_1$ ,  $D_2$  and  $Z_2$  will become non-exchangeable (figure 9).

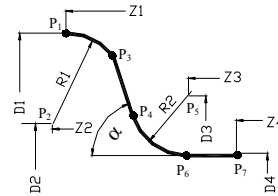

**Figure 9** Non-tangent conjunction in  $P_3$  point

In case of definition of parameters  $\alpha$ ,  $R_2$ ,  $Z_3$  and  $D_3$ , non-tangent conjunction in  $P_4$ ,  $P_6$  points will occur (figure 10). In case of definition of  $Z_3$ ,  $D_3$  parameters and tangent conjunction of line in  $P_4$  point, parameters  $\alpha$  and  $R_2$  are exchangeable. In this case depending on whether,  $D_4$  parameter is defined or not, the conjunction in  $P_6$  point will be either non-tangent or tangent. If tangent conjunction in  $P_6$  is carried out and parameters  $D_3$ ,  $Z_3$  are defined, the parameter  $R_2$  is calculated and also depending on whether the conjunction in  $P_4$  point is tangent or non-tangent, parameter  $\alpha$  will be calculated or defined. If parameters  $Z_3$ ,  $D_3$  are not defined, the tangent conjunction in  $P_4$ ,  $P_6$  points will exist.

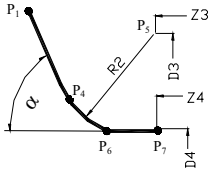

Figure 10 Non-tangent conjunction in P4 P6 points

### 5. CONSIDERATION OF TYPICAL STRUCTURES

By connecting the conjunction point P1 and the line L2 in structural equation (2) with typical conjunction group 3-2, we can receive structural a formula for half-open stair presented on figure 7:

$$STHO = \{P_1 \wedge (C_1 \vee L_1 \vee C_2) \vee L_2\} \quad (3)$$

Where, P<sub>1</sub> is a conjunction point; C<sub>1</sub>, C<sub>2</sub> - arcs; L<sub>1</sub> - conic; L<sub>2</sub> - cylinder;  $\wedge$  logical AND;  $\vee$  logical OR.

Formula express the main geometrical feature of a half-open stair and is a base for separation of a class of typical structures Sharmazanashvili (2002). According to (3), 16 typical classes of structures is separated. Below is given a class description with corresponding scheme of parameterization.

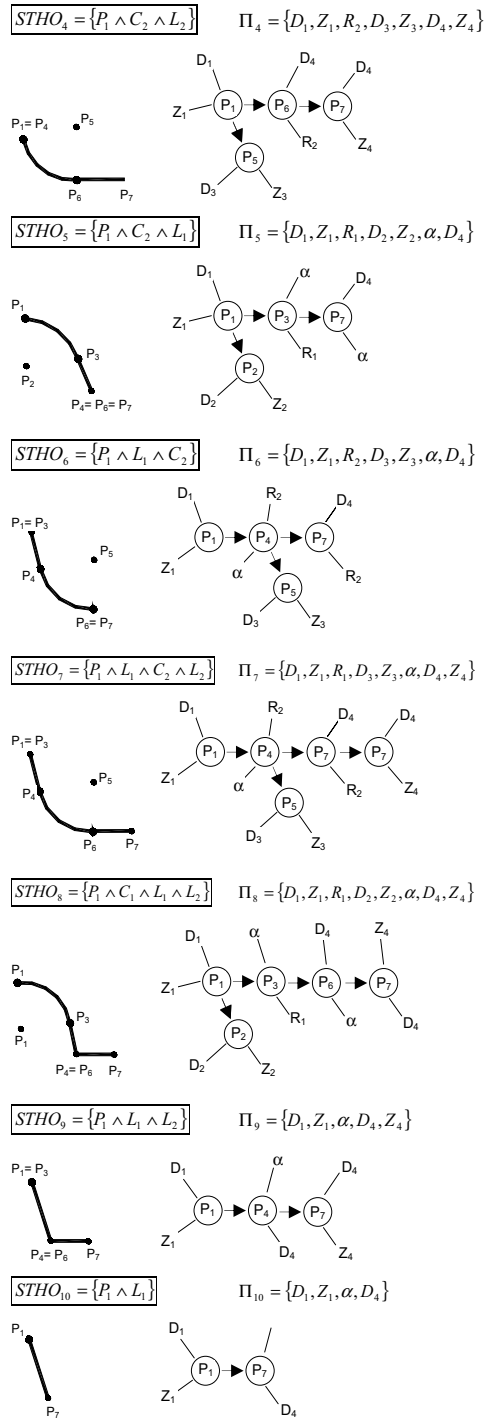
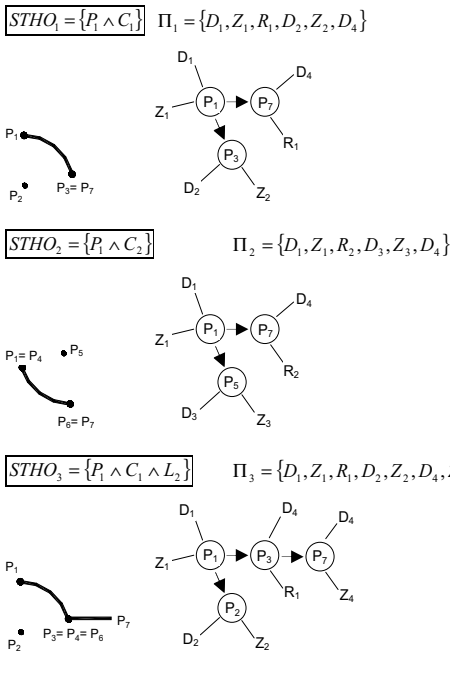

$$STHO_{11} = \{P_1 \wedge C_1 \wedge C_2\} \quad \Pi_{11} = \{D_1, Z_1, D_2, Z_2, R_1, D_3, Z_3, R_2, D_4\}$$

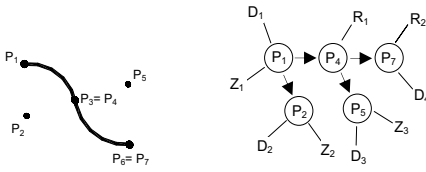

$$STHO_{12} = \{P_1 \wedge C_1 \wedge C_2 \wedge L_2\}$$

$$\Pi_{12} = \{D_1, Z_1, D_2, Z_2, R_1, D_3, Z_3, R_2, D_4, Z_4\}$$

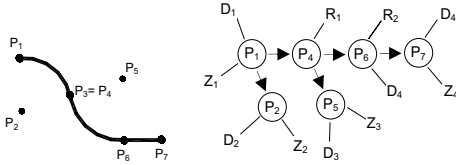

$$STHO_{13} = \{P_1 \wedge C_1 \wedge L_1 \wedge C_2\}$$

$$\Pi_{13} = \{D_1, Z_1, D_2, Z_2, R_1, \alpha, D_3, Z_3, R_2, D_4\}$$

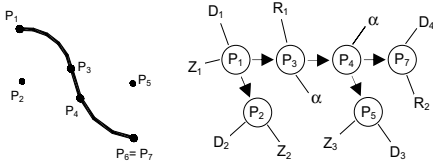

Conjunction in  $P_3$  is always tangent

$$STHO_{14} = \{P_1 \wedge C_1 \wedge L_1 \wedge C_2\}$$

$$\Pi_{14} = \{D_1, Z_1, D_2, Z_2, R_1, \alpha, D_3, Z_3, R_2, D_4\}$$

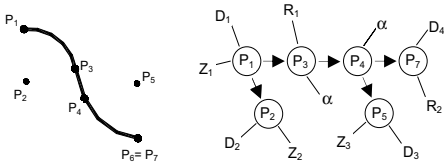

Conjunction in  $P_4$  is always tangent

$$STHO_{15} = \{P_1 \wedge C_1 \wedge L_1 \wedge C_2 \wedge L_2\}$$

$$\Pi_{15} = \{D_1, Z_1, D_2, Z_2, R_1, \alpha, D_3, Z_3, R_2, D_4, Z_4\}$$

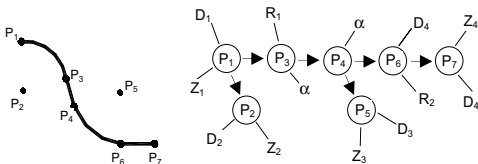

Conjunction in  $P_3$  is always tangent

$$STHO_{16} = \{P_1 \wedge C_1 \wedge L_1 \wedge C_2 \wedge L_2\}$$

$$\Pi_{16} = \{D_1, Z_1, D_2, Z_2, R_1, \alpha, D_3, Z_3, R_2, D_4, Z_4\}$$

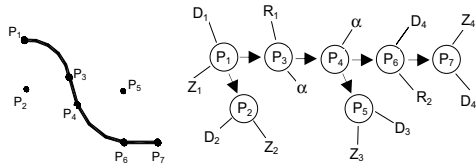

Conjunction in  $P_4$  is always tangent

Our research shows that according to different combination of parameters, the original modifications of considered above classes can be separated. Particularly, from typical structures STHO1, STHO2, STHO3, STHO4, STHO8 – 2 modifications from each will be received; from STHO6, STHO7, STHO10, STHO11, STHO13, STHO15 – 4 modification from each; from STHO5 – 6 modification; from STHO12 and STHO14 – 8 modification from each; from STHO9 and STHO16 – 1 modification from each. Total number of modifications is 58. Thus, main structure of half-open stair on figure 7 and corresponding formula (3), unify 58 typical shapes which can be received by original combination of formal parameters.

## 6. FINAL SYSTEMATIZATION OF SHAPES

Geometrical structure (3) represents the half-open shape. However, as it was mentioned above, two additional shapes in form of closed and open stairs are also belongs to common types of manufacturing shapes. Below final systematization of shapes on the base of half-open structure is done.

Closed stair is built on the base of composition of half-open stair with its mirror structure (figure 11).

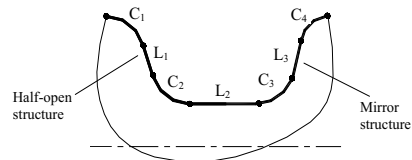
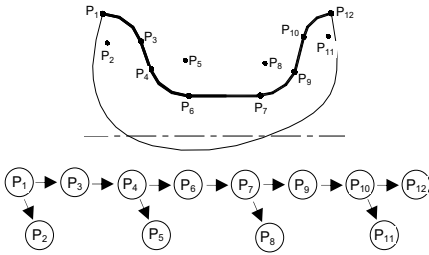

Figure 11 Closed stair STCL

The structural formula of closed stair, in this case will be

$$STCL = \{P_1 \wedge (C_1 \vee L_1 \vee C_2) \vee L_2 \wedge (C_3 \vee L_3 \vee C_4)\} \quad (4)$$

By marking of conjunction points in the structure the, formal representation of a closed stair in form of a graph can be received (figure 12)



**Figure 12** Representation of geometrical structure of STCL

The corresponding scheme of parameterization according to parameterization rules of a half-open stair will be following (figure 13).

For separation of typical structures from (4), a closed stair was considered as a combination of two opposite half-open stairs  $STHO^+ = \{P_1..P_7\}$  and  $STHO^- = \{P_7..P_{12}\}$ . Thus, it is possible to determine a full array of typical structures of a closed stair by multiplication of two arrays  $\{R^+ \times R^-\}$ , where  $R^+$  is an array of typical structures of  $STHO^+$  and  $R^-$  - an array of typical structures of  $STHO^-$ .  $R^+$  array has been already considered above and there exist 16 classes of typical structures. In case of  $R^-$ , this array unifies mirror structures of  $R^+$  except of structures  $STHO3$ ,  $STHO4$ ,  $STHO7$ ,  $STHO8$ ,  $STHO9$ ,  $STHO11$ ,  $STHO14$ ,  $STHO15$ , because  $STHO^-$  is described on conjunction points  $\{P_7..P_{12}\}$  and line  $L_2$  does not refer to the structure. Therefore, all typical structures, where  $L_2$  line is presented, have to be omitted from  $R^-$  array consideration. The total number of typical structures in  $R^-$  is 8.

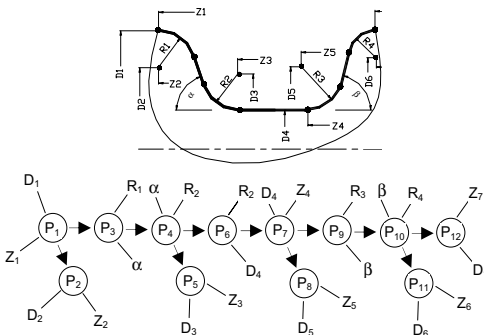

**Figure 13** Parameterization scheme of STCL

Thus, the total number of the closed stair, separated from (4) will be  $\{R^+ \times R^-\} = \{16 \times 8\} = 128$ .

In same way, it is possible to determine original modifications of typical structures of a closed stair. As it was considered above a half-open stair has 58 original modifications. Therefore,  $STHO^+$  structure also will have 58 modifications. In case of  $STHO^-$ , from the total number have to be omitted those modifications which are corresponding to mirror structures of  $STHO3$ ,  $STHO4$ ,  $STHO7$ ,  $STHO8$ ,  $STHO9$ ,  $STHO11$ ,  $STHO14$ ,  $STHO15$  - with the total number of 31.

As a result, the total number of modifications is  $58 \times 31 = 1798$

Thus, we have received two main geometrical structures of typical shapes:

- 1) Half-open stair  $STHO$  with 58 original modifications
- 2) Closed stair  $STCL$  with 1798 original modifications.

Structures  $STHO$  (3) and  $STCL$  (4) are the base for the separation of the wide range of typical manufacturing shapes. In case of turning following typical shapes can be developed on the basis of the considered structures:

**1** A half-open cylindrical shape - described from one side by  $STHO$  and cylindrical and end\_face surfaces of a workpiece from other side  $Z_{HO}^E = \psi(STHO)$

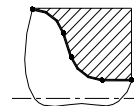

**2** A half-open groove shape - described from one side by mirror structure of  $STHO$  and cylindrical and end\_face surfaces of a workpiece from other side  $Z_{HO}^L = \psi(|STHO|_{180^\circ})$

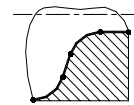

**3** A closed cylindrical shape - described from one side by  $STCL$  and a cylindrical surface of workpiece from other side  $Z_{CL}^E = \psi(STCL)$

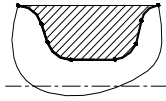

4] A closed groove shape - described from one side by a mirror structure of STCL and a cylindrical surface of a workpiece from the other side  $Z_{CL}^I = \psi(|STCL|_{180^\circ})$

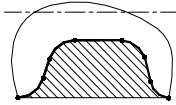

5] A closed end\_face shape - described from one side by rotated on 90 degree clockwise direction structure of STCL and end\_face surfaces of a workpiece from the other side  $Z_{CL}^P = \psi(|STCL|_{90^\circ})$

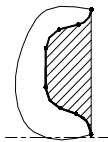

6] An open cylindrical shape - described from one side by a mirror structure of STCL and a cylindrical surface of the part from the other side  $Z_{OP}^E = \psi(|STCL|_{180^\circ})$



7] An open groove shape - described from one side by STCL and cylindrical surface of the part from other side  $Z_{OP}^I = \psi(STCL)$

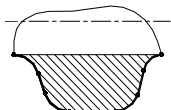

8] An open end\_face shape - described from one side by rotated on 270 degree clockwise direction structure of STCL and end\_face surfaces of the part from the other side  $Z_{OP}^E = \psi(|STCL|_{90^\circ})$

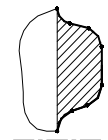

## 7. FORMALIZATION OF MANUFACTURING PROCESSES

The goal of manufacturing process formalization is separation of manufacturing features for the above considered shapes. While manufacturing processes are characterized with its originality, the below given consideration expressed just only basic developments.

Machining of half-open stair STHO is preferable to be done by tools with main angle in plane more then  $90^\circ$ . In this case two types of cutters will be used:

1.  $T_{1HO} = \{\varphi=95^\circ \varphi_1=5^\circ\}$  - for rough cutting (Figure 14 a)
2.  $T_{1HO} = \{\varphi=95^\circ \varphi_1=5^\circ\}$  - for finish cutting (Figure 14 b)

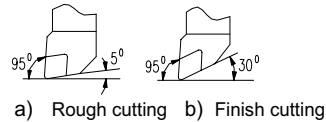

Figure 14 Tools for machining of STHO

Roughing cut of STHO will do according to 4 point closed cycle movement concept. Depending on weather this movement is carried out fast, or on federate, two different sub-rules are separated:

$M_{1-1}$  - "Fast->Feedrate->Fast->Fast"

$M_{1-2}$  - "Fast->Feedrate->Feedrate->Fast"

$M_{1-1}$  rule describe tool fast movement from  $P_1$  starting point to  $P_2$  point, then movement on feedrate up to  $P_3$  conjunct point, which is placed on part surface (Figure 15 a); then fast movement across the  $45^\circ$  angled line, up to  $P_4$  point with transferring on 1mm and back fast movement in  $P_5$  point.

$M_{1-2}$  rule describe tool fast movement from  $P_1$  starting point to  $P_2$  point (Figure 15 b), then feedrate movement up to  $P_3$  point, which is placed on part surface, then feedrate movement across the part surface in  $P_4$  with transferring on predefined depth of cut ( $t$ ) and back fast movement in  $P_5$  point.

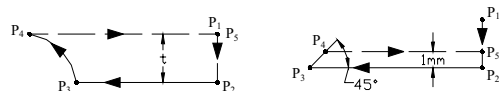

Figure 15 Tool movement rules



Finish cutting of STHO will do according to equidistant movement concept. There are two sub-rules –  $M_{2-1}$  describes equidistant movement with scaling and  $M_{2-2}$  equidistant movement without scaling (Figure 16).

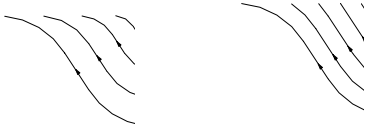

Figure 16 Equidistant tool movement rules

Therefore, for half-open cylindrical stair  $Z_{HO}^E$  following typical structures of manufacturing processes can be separated:

$$\begin{cases} Z_{HO}^E \rightarrow T_{1HO}^E \rightarrow M_{1-1}^L \\ Z_{HO}^E \rightarrow T_{1HO}^E \rightarrow M_{1-1}^D \\ Z_{HO}^E \rightarrow T_{1HO}^E \rightarrow M_{1-2}^L \\ Z_{HO}^E \rightarrow T_{1HO}^E \rightarrow M_{1-2}^D \\ Z_{HO}^E \rightarrow T_{2HO}^E \rightarrow M_{2-1} \\ Z_{HO}^E \rightarrow T_{2HO}^E \rightarrow M_{2-2} \end{cases} \quad (5)$$

Where,  $M_{1-1}^L, M_{1-2}^L$  - describes a longitudinal movement,  $M_{1-1}^D, M_{1-2}^D$  - diametrical movement.

The corresponding manufacturing feature formalism is presented in table 1.

$f(v,s)$  Function in feature formalism represents typical rules for optimization of machining conditions  $V$  and  $S$ . A detailed consideration of this rules is out of the goal of the current paper and is presented in sources – Sharmazanashvili (1993) and Sharmazanashvili (1994).

In the same way, typical structures of manufacturing processes for a half-open grooving stair  $Z_{HO}^I$  can be formed

$$\begin{cases} Z_{HO}^I \rightarrow T_{1HO}^I \rightarrow M_{1-1}^L \\ Z_{HO}^I \rightarrow T_{1HO}^I \rightarrow M_{1-1}^D \\ Z_{HO}^I \rightarrow T_{1HO}^I \rightarrow M_{1-2}^L \\ Z_{HO}^I \rightarrow T_{1HO}^I \rightarrow M_{1-2}^D \\ Z_{HO}^I \rightarrow T_{2HO}^I \rightarrow M_{2-1} \\ Z_{HO}^I \rightarrow T_{2HO}^I \rightarrow M_{2-2} \end{cases} \quad (6)$$

Table 1 Manufacturing feature CTFI

Geometry	Tool	Path Concept	Machining conditions
			$f(v,s)$
			$f(v,s)$
			$f(v,s)$
			$f(v,s)$
			$f(v,s)$
			$f(v,s)$

Machining of a closed stair STCL can be done by grooving tool  $T_{1CL}$  (Figure 17 a) according to 3 point closed cycle movement (M3). The tool movement is starting on feedrate from the  $P_1$  point; continues moving along the X or Z axis parallel line up to  $P_2$  point and is finished by a back fast movement in  $P_1$  initial point (Figure 17 c).

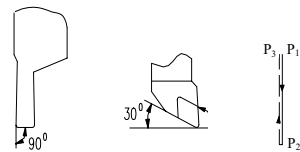
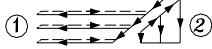

Figure 17 Tool set for machining of STCL

In case of machining of a wide closed stair more efficient is use implementation of  $T_{1HO}$  and  $T_{2HO}$  with

combined rules of 4 point closed cycle movement. Different combinations of movement rules sequence will be considered:

1)  $M_{1-1} + M_3$  – initially, by  $T_{2HO}$  tool, according to 4 point closed cycle movement rule  $M_{1-1}$ , the main part of STCL stair is machining. Then, the rest of the part is machined by  $T_{1CL}$  tool, according to the 3 point closed cycle movement rule  $M_3$ .



2)  $M_3 + M_{1-1}$  – initially, according to  $M_3$  rule, the minimal part of STCL stair is removed by  $T_{1CL}$  tool. On the next step the main part of STCL stair is machining by  $T_{1HO}$  tool, according to the 4 point closed cycle movement rule  $M_{1-1}$ .



3)  $M_{1-1} + M_{1-1}$  – machining is started by  $T_{2HO}$  tool, according to the 4 point cycle movement rule  $M_{1-1}$ ; rest of the part is machining by a right handed tool  $T_{2CL}$  (Figure 17 b) according to the same  $M_{1-1}$  rule.



Therefore, for a closed cylindrical stair  $Z_{CL}^E$  following typical structures of manufacturing processes can be separated:

$$\left\{ \begin{array}{l} Z_{CL}^E \rightarrow T_{1CL}^E \rightarrow M_3 \\ Z_{CL}^E \rightarrow T_{2HO}^E \rightarrow M_{1-1} \\ \quad \quad \quad T_{1CL}^E \rightarrow M_3 \\ Z_{CL}^E \rightarrow T_{1CL}^E \rightarrow M_3 \\ \quad \quad \quad T_{1HO}^E \rightarrow M_{1-1} \\ Z_{CL}^E \rightarrow T_{2HO}^E \rightarrow M_{1-1} \\ \quad \quad \quad T_{2CL}^E \rightarrow M_{1-1} \end{array} \right. \quad (7)$$

The corresponding manufacturing feature formalism is presented in table 2.

In same way, Typical structure of manufacturing process for closed grooving stair can be formed

$$\left\{ \begin{array}{l} Z_{CL}^I \rightarrow T_{1CL}^I \rightarrow M_3 \\ Z_{CL}^I \rightarrow T_{2HO}^I \rightarrow M_{1-1} \\ \quad \quad \quad T_{1CL}^I \rightarrow M_3 \\ Z_{CL}^I \rightarrow T_{1CL}^I \rightarrow M_3 \\ \quad \quad \quad T_{1HO}^I \rightarrow M_{1-1} \\ Z_{CL}^I \rightarrow T_{2HO}^I \rightarrow M_{1-1} \\ \quad \quad \quad T_{2CL}^I \rightarrow M_{1-1} \end{array} \right. \quad (8)$$

**Table 2** Manufacturing feature CTF3

Geometry	Tool	Path Concept	Machining conditions
			$f(v,s)$
			$f(v,s)$
			$f(v,s)$
			$f(v,s)$
			$f(v,s)$
			$f(v,s)$

Closed end\_face stair  $Z_{CL}^P$  is machined by grooving tool  $T_{1CL}$  according to the 3 point closed cycle movement rule  $M_3$ . Therefore,

$$\left\{ Z_{CL}^P \rightarrow T_{1CL} \rightarrow M_3 \right\} \quad (9)$$

Machining of an open stair can be done by  $T_{1HO}$  tool according to 4 point cycled movement rule  $M_{1-1}$  in longitudinal and diametrical directions; by  $T_{1CL}$  grooving tool, according to 3 point cycled movement rule  $M_3$ . In addition implementation of special tool with main angles in plane less than  $90^\circ$  -  $T_{1OP}$  will ensure high efficiency of material removing process

(Figure 18 a). Tool movement will be realized by special 5 point non-cycled rule  $M_4$

$M_{1-1}$  – “Fast->Feedrate->Feedrate->Fast”

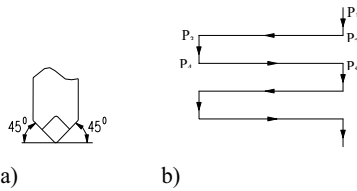

**Figure 18** 5 Point non-cycled rule of tool movement

According to this rule, tool fast movement is starting from  $P_1$  initial point to  $P_2$  point, then tool is moving on feedrate along the part final surface and removing material up to  $P_3$  point, then tool is going down in  $P_4$  point on predefined depth of cut ( $t$ ) and coming back on feedrate along the part final surface with removing material (Figure 18 b).

Thus, following typical structures of manufacturing processes for open cylindrical stair  $Z_{OP}^E$  can be separated:

$$\begin{cases} Z_{OP}^E \rightarrow T_{1HO}^E \rightarrow M_{1-1}^L \\ Z_{OP}^E \rightarrow T_{1HO}^E \rightarrow M_{1-1}^D \\ Z_{OP}^E \rightarrow T_{1CL}^E \rightarrow M_3 \\ Z_{OP}^E \rightarrow T_{1OP}^E \rightarrow M_4 \end{cases} \quad (10)$$

The corresponding manufacturing feature formalism is presented in table 3. In same way typical structures of manufacturing processes for open grooving stair  $Z_{OP}^I$  and end\_face stair  $Z_{OP}^P$  can be formed:

$$\begin{cases} Z_{OP}^I \rightarrow T_{1HO}^I \rightarrow M_{1-1}^L \\ Z_{OP}^I \rightarrow T_{1HO}^I \rightarrow M_{1-1}^D \\ Z_{OP}^I \rightarrow T_{1CL}^I \rightarrow M_3 \\ Z_{OP}^I \rightarrow T_{1OP}^I \rightarrow M_4 \end{cases} \quad (11)$$

$$\begin{cases} Z_{OP}^P \rightarrow T_{1HO}^E \rightarrow M_{1-1}^L \\ Z_{OP}^P \rightarrow T_{1HO}^E \rightarrow M_{1-1}^D \\ Z_{OP}^P \rightarrow T_{1CL}^E \rightarrow M_3 \\ Z_{OP}^P \rightarrow T_{1OP}^E \rightarrow M_4 \end{cases} \quad (12)$$

**Table 3** Manufacturing feature CTF6

Geometry	Tool	Path Concept	Machining conditions
			$f(v, s)$
			$f(v, s)$
			$f(v, s)$
			$f(v, s)$

## 8. IMPLEMENTATION OF CTF LIBRARY

On the base of the above considered array of CTF, a software application in form of library of fixed cycles was built in Moscow “TEMP” organization for turning center STR-25 with CNC system MC2106.

Below is given examples of CTF implementation for typical parts “Perehodnik” (Figure 19), and “Nakonechnik” (Figure 20) produced at some military enterprises of Russia.

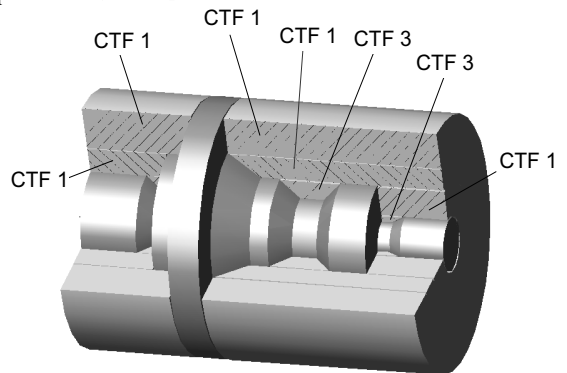

**Figure 19** Implementation of CTF for typical part “Perehodnik”

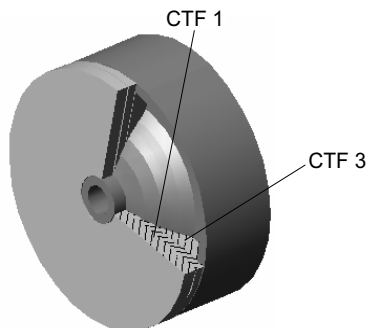

**Figure 20** Implementation of CTF for typical part “Nakonechnik”

## CONCLUSIONS

1. Two main geometrical structures, half-open stair STHO and closed stair STCL for systematization of non-complex 2D surfaces of product, is separated.
2. Parameterization scheme enables to receive 58 original modifications of a half-open stair and 1798 original modifications of closed stair.
3. Eight manufacturing features CTF1..CTF8 have been worked out on the base of half-open and closed stairs.
4. Flexible parameterization possibility of STHO and STCL stairs enables to describe non-complex part geometry on the base of CTF library and ensure manufacturability of the product geometry on the initial stages of PPM.
5. CTF library can be considered as a knowledge connectivity platform in PPM and integration base of CA tools of product/process modeling and CNC control systems.
6. Implementation of CTF-based design approach will increase reliability of decision making process in PPM and improve NC program adaptation ability on undefined conditions of machining.

## REFERENCES

- [1] Owen R., Horvath I. (2002) “Towards product-related knowledge asset warehousing in enterprises”. *Tools and Methods of competitive engineering*,

*TMCE, Fourth International symposium, April 22-26, 2002, Wuhan, P.R.China, pp. 155-170*

- [2] Boothroyd G., Dewhurst P. (1989) “Product design for assembly” *Boothroyd Dewhurst, Inc.*
- [3] Naskidashvili T. (2002) “Development of extended approach of DFMA” *Masters degree thesis, Georgian Technical University*
- [4] Kapustin N. (1976) “Development of technological processes of part machining on the NC machine tools” *Mashinostroenie, Moscow*
- [5] Poldermann B. and Horváth I., (1996), “Surface based design based on parameterized surface features”, *Proceedings International Symposium on Tools and Methods for Concurrent Engineering*, 29-31 May, Budapest, pp. 432-446
- [6] Sharmazanashvili A. (1991) “Development of adaptive part programming approach in FMS” *Ph.D. dissertation, Moscow State Technical University of Bauman*
- [7] Sharmazanashvili A., Megrelishvili L. (1998) “Feature-based approach in CAD/CAM/CNC Integration” in *Transactions of 2nd International Symposium of Tools and Methods of Concurrent Engineering*, 1998, 19-21 April, Manchester, UK, pp.423-431
- [8] Sharmazanashvili A. (2002) “CAPP customization on the base of object-oriented approach” *Tools and Methods of competitive engineering, TMCE, Fourth International symposium, April 22-26,2002, Wuhan, P.R.China, pp.751-762*
- [9] Sharmazanashvili A. N., (1994), Roughing cuts optimization method in adaptive control, in *Transaction of Georgian Technical University ISSN 0201-7146*, no.1, pp.57-71. (in Russian)
- [10] Sharmazanashvili A. (1993) About the item of research of optimal cutter conditions influence on the technological disturbances, in *Transaction of Georgian Technical University. ISSN 0201-7146*.-no. 10, 1993. (in Russian)
- [11] Makarov A. (1966) “Wear and tool life period of cutting tools” *Mashinostroenie, Moscow*
- [12] Popov V. (1963) “Principles of development of manufacturing technology” *Mashgiz, Moscow*
- [13] Deriabin A. (1984) “Programming of technological processes for CNC machine tools” *Mashinostroenie, Moscow*